

DETAIL B
FLOOR HOLE CUT SIZE 200mm

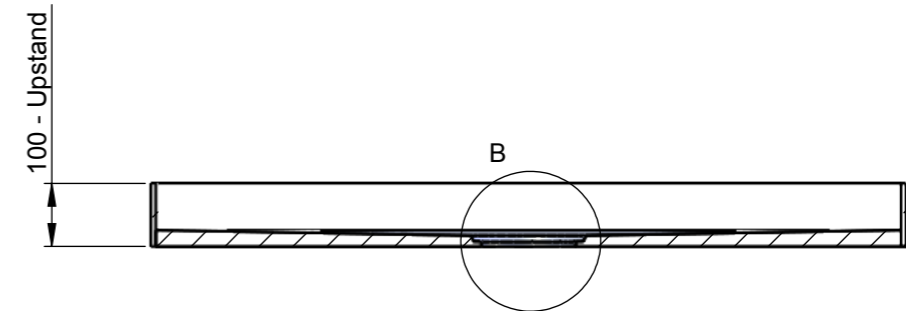

SECTION A-A
SCALE 1 : 12